

50-NOVA-SSL-WR

SOLAR ROAD LIGHT

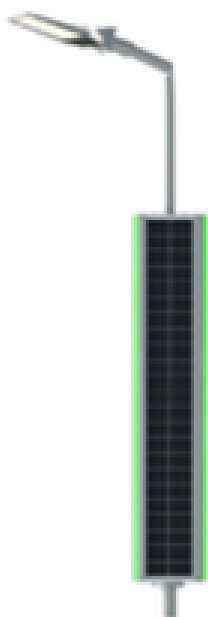

Solar Panel Mono crystalline silicon, 25.76V/ 57.5W*3PCS

Diffuser Clear PC

- Benefits**
- High quality workmanship, integrated design
 - Modular pluggable technology providing, easy installation and maintenance
 - Intelligent dimming, customized illumination, lower depreciation, longer lifespan
 - Suitable for internal roads and garden areas

LIGHT SOURCE

- Philips top advanced LED chips
- Efficiency, lifespan and reliability comply with international standards
- Flexible CCT options from warm 3000K to cold 6500K
- Designed for different illumination environments.

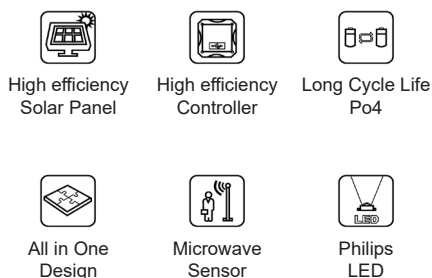

SPECIFICATION

	50-NOVA-SSL-WR-30 30W	50-NOVA-SSL-WR-60 60W
Chip Type	Lumiled	Lumiled
Number of LED	72pc	144 pc
Lithium Battery	20.8Ah, 461.76WH	26Ah, 577.2WH
Solar Panel	Monocrystalline silicon, 25.76V	Monocrystalline silicon, 25.76V
Wattage	30W	60W
Lumen Efficiency	230 lm / w	230 lm / w
CCT**	3000K / 4000K / 5000K / 5700K / 6500K	3000K / 4000K / 5000K / 5700K / 6500K
CRI (Ra)	≥70	≥70
LED Life	50,000 hrs	50,000 hrs
Working Ambient Temperature	-10°C ~ +55°C	-10°C ~ +55°C
Working Humidity	10% ~ 90%	10% ~ 90%
Controller	40W / 10A	80W / 10A
Lumen	6900 lm	13800 lm

**CCT Tolerance ±5%

Data is subject to change without notice.

* Height varies on actual application



Solar panel		
Power	Monocrystalline silicon, 25.76V/ 57.5W*3PCS	Monocrystalline silicon, 25.76V/ 76.6W*3PCS
Battery		
Capacity	20.8Ah, 461.76WH	26Ah, 577.2WH
Charging / Discharging Temp	-10°C~+55°C / -20°C~+60°C	
Charging Time	≤8H by Strong sunshine	
LED	3030, 4000K 72pcs	3030, 4000K 144pcs
Color Temp	4000K, RA>70	
Efficiency	230lm/W	
Types of Lighting	TYPE-II (M)	
LED Indicator		
Charging	Flash	
Lighting Mode Indicator	M1: The 1st Led indicator on M2: The 2nd Led indicator on M3: The 3rd Led indicator on	
SET SWITCH		
Power ON / OFF	Long press 1.5s	
Change Lighting Mode	Short press ,M2-M3-M1	
Reset	Long press 6s	
Battery Indicator	>80%: 4 red Leds on; >60%: 3 red Leds on; >20%: 2 red Leds on; >0%: 1 red Leds on	
AC adapter (Customize)		
Function description	Charging Battery and Power the lamp when the battery is low power	
Remote control (Customize)		
ON	Short press to turn on the light	
OFF	1. Short press to turn off the light 2.Reset: Long press 6s	
M1/M2/M3	Change Lighting Mode	
T (Available for hybrid version product)	Mode: Hybrid—AC only—Battery only	
Led strip		
Power Supply Mode Indication	Green: Powered by battery White: Powered by AC OFF: Battery is low power	
Comprehensive		
Lighting Time in Rainy Days	>8 Days	
Power ON / OFF	Switch/Remote Controller	
Mode Control	Switch/Remote Controller	
Lighting Mode	M1: 30% till dawn M2: 100%(5H)+25%(5H)+70%till dawn (Default mode) M3: 70% till dawn	
Maximum Lighting Area(m ²)	150m ²	220m ²
Install Height / Distance	8m / 22m	10m / 24m
Main part	Lamp: AL; Main body: SUS201+AL	
IP / IK Class	IP65 / IK08	
Core technology	ALS2.4	

Data is subject to change without notice.

50-NOVA-SSL-WR

SOLAR ROAD LIGHT

SOLAR PANEL

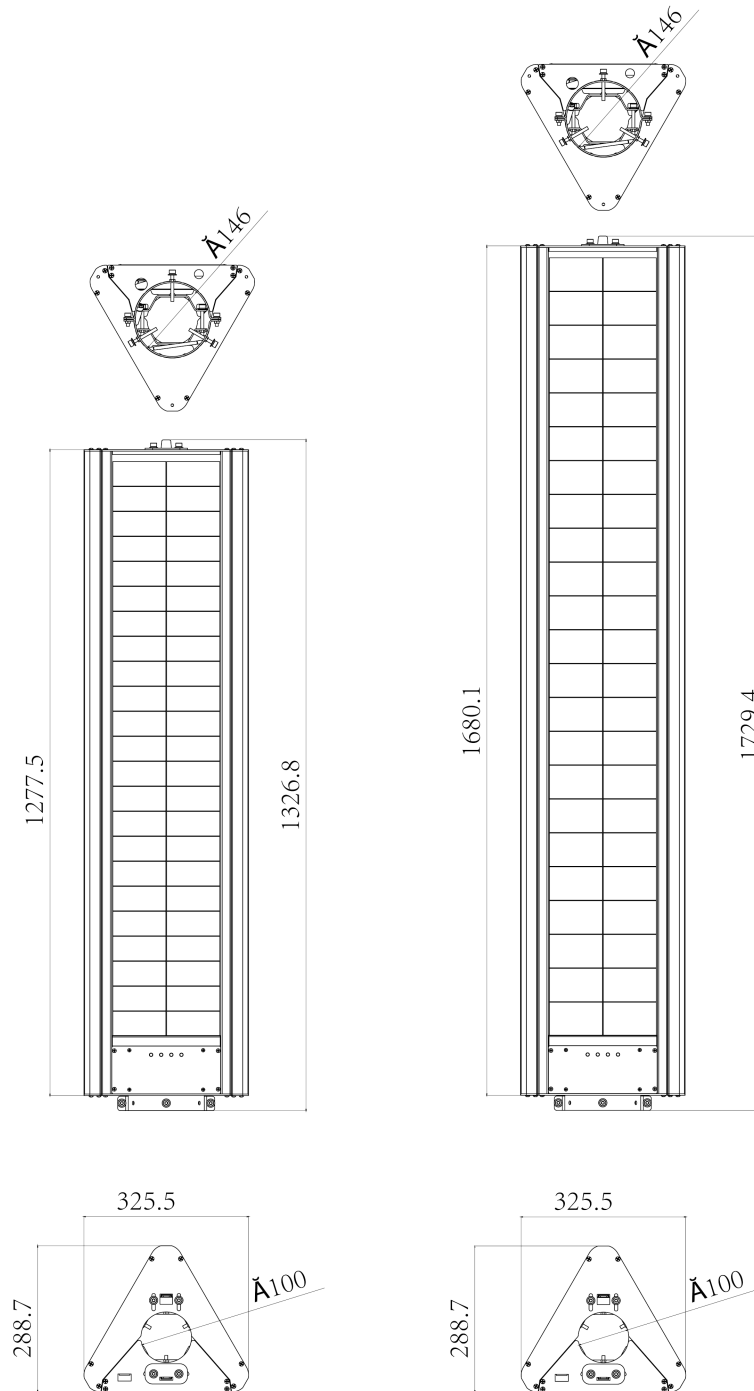

Data is subject to change without notice.

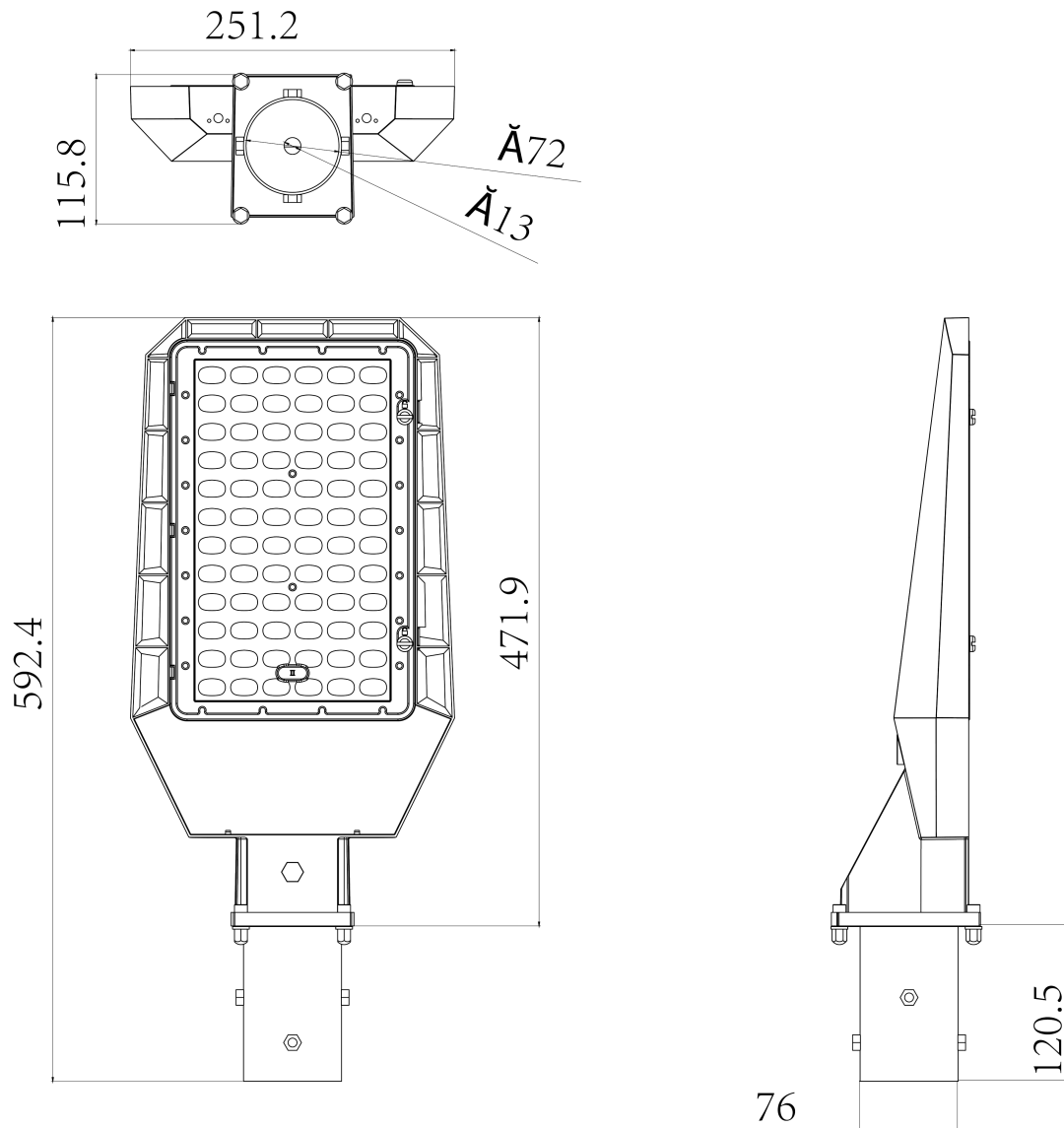

Data is subject to change without notice.

50-NOVA-SSL-WR

SOLAR ROAD LIGHT

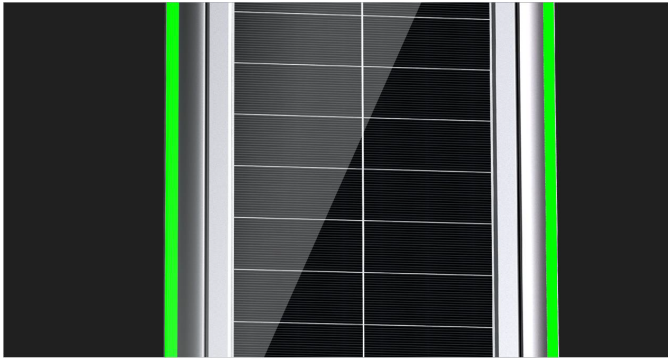

Monocrystalline silicon

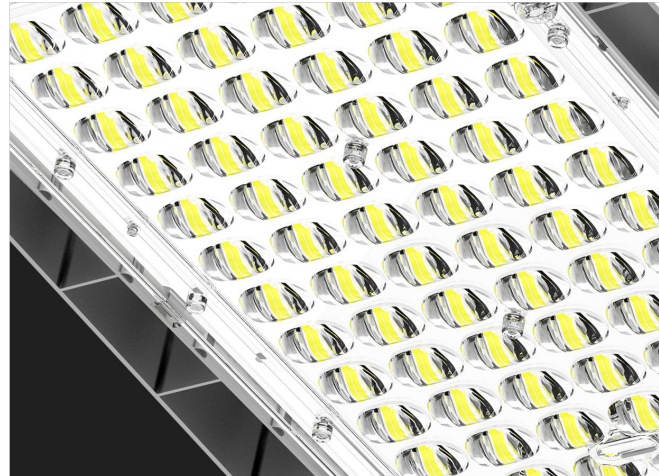

High lumen LEDs 230lm/W

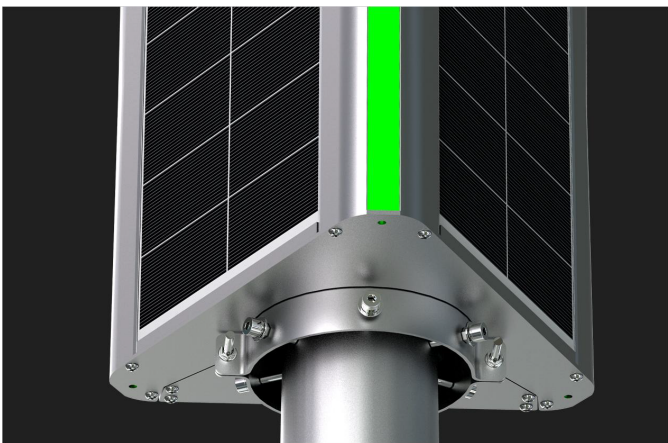

Hoop



Hidden power switch & IR receiver

Data is subject to change without notice.

50-NOVA-SSL-WR

SOLAR ROAD LIGHT

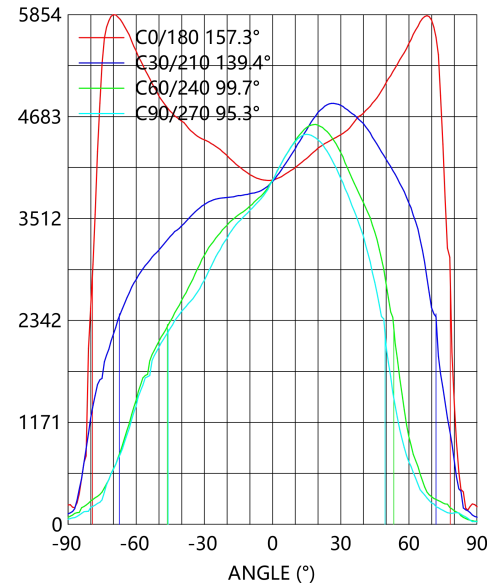
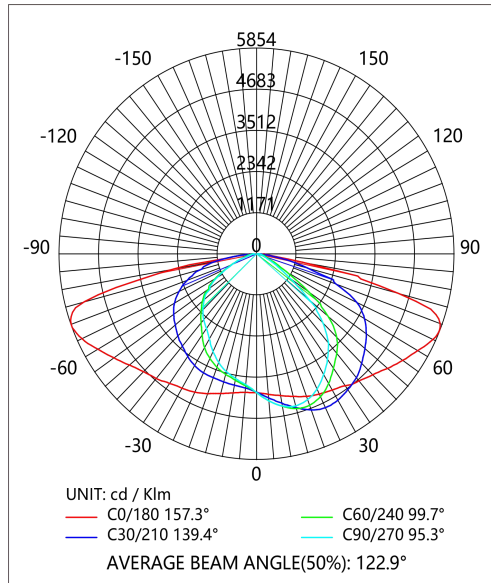
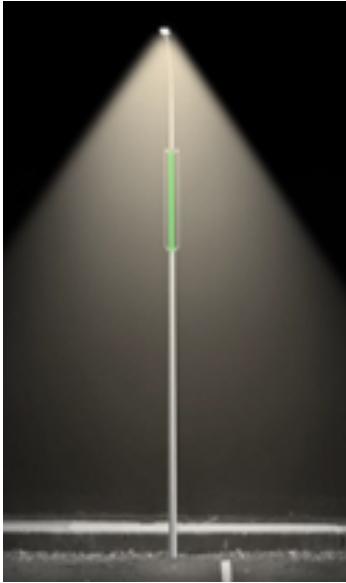

REMARKS

1. Products specification depend on specific model.
2. All wiring are waterproof and comply with international standards.
3. Only qualified personnel maintain or repair to avoid damage.
4. Controller testing and setting according to manual instructions.
5. Installation site should be away from shadow of tree or building.
6. Regular clean suggested for dusty area to maximize the solar generation.
7. Lamp switch should turn off during transit.

ORDERING GUIDE

50-NOVA-SSL-WR-30-730	30W	50-NOVA-SSL-WR-60-730	60W
50-NOVA-SSL-WR-30-740	30W	50-NOVA-SSL-WR-60-740	60W
50-NOVA-SSL-WR-30-750	30W	50-NOVA-SSL-WR-60-750	60W
50-NOVA-SSL-WR-30-757	30W	50-NOVA-SSL-WR-60-757	60W
50-NOVA-SSL-WR-30-765	30W	50-NOVA-SSL-WR-60-765	60W

ORDERING EXAMPLE

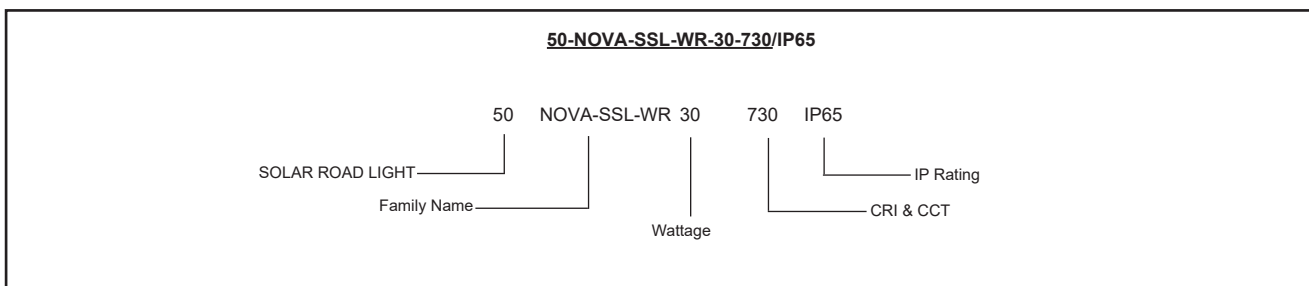

SOLAR ROAD LIGHT NOVA-SSL-WR 30 730/IP65

Data is subject to change without notice.